

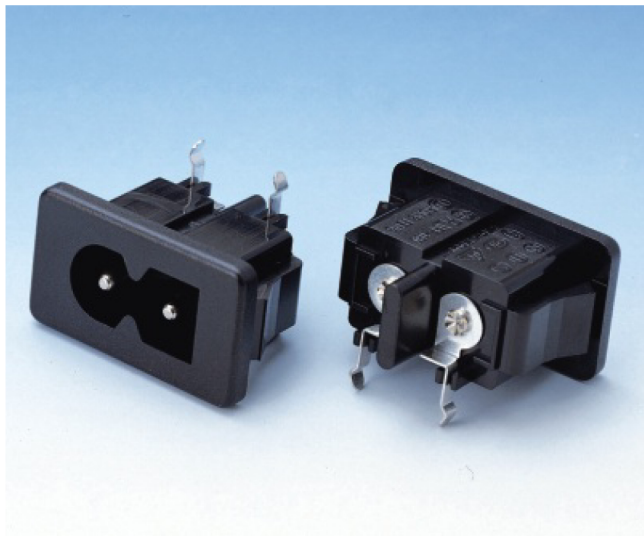

宏钰电子（嘉善）有限公司
HONGYU ELECTRICAL (JIASHAN) CO.,LTD.

Add:No,69 Jinxiu Road East City Development Zone,
Jiashan,Zhejiang,China
Tel:86 573 84062088 , 84062188
Fax:86 573 84062898
<http://www.hongyuzj.com>
E-mail:henry@hongyuzj.com

AC SOCKET



RF-180-J

STANDARD:IEC 320 C8
RATING:2.5A/250V AC
APPROVALS:UL/CSA/VDE/ÖVE/SEV/
DEMKO/NEMKO/SEMKO/FIMKO

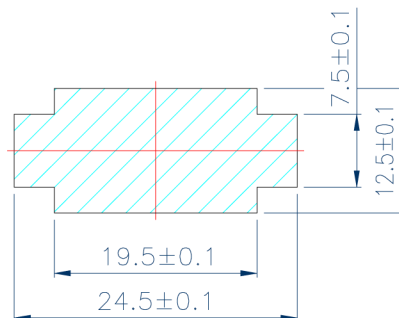
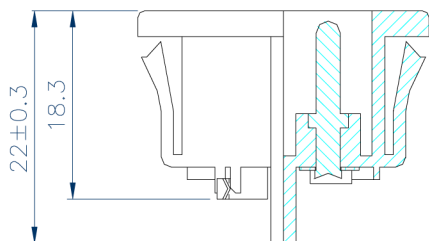
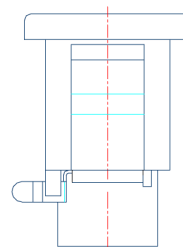
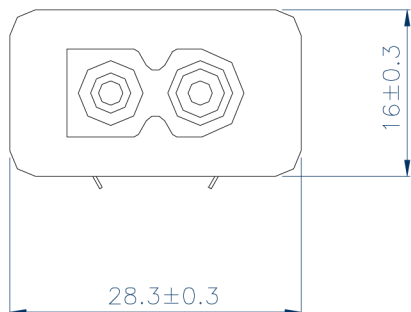

PANEL CUTOUT THICKNESS 0.6mm~2.0mm